







* PRODUCT DATASHEET

- * Model: HX-13HEX-75L
- * Dimensions:
 Lens: regular hexagon L=8.0mm H7.30mm
 striped cylinder holder: N/A
 bipod striped cylinder holder: N/A
- * Materials:
 Lens: Optical Grade PMMA / PC
 Holder: N/A
- * Assembly Dimensions:
 Lens with striped cylinder holder: N/A
 Lens with bipod striped cylinder holder: N/A
- * Surface Treatment: Beads Surface
- * IP Ratings: IP65
- * Beam Angle: 75 deg
- * For Led:
 CREE X-PC/E/G/G2/TE     
 Seoul Acriche Z5  Federal 3535 
 Nichia 119A  LG/Samsung 3535 
 OSRAM OSLON SSL/Square   
- * Certification: SGS RoHs



- *Features:
 High efficiency
 Available in 1 beam Patterns
 Optimized for uniform effects
 Lens without holder
- *Typical applications:
 Stage lighting
 Street lights
 Decorative light
 Architectural lighting
 Down light
 Underwater light
 Flashlight

* Brief description :

- *The OPTIC-FOV (Shenzhen Hongxuan Optoelectronic Technology Co., Ltd) lens offers low-profile lenses specifically designed for the Luxeon® LEDs, Edison® LEDs, Bridgelux® LEDs or Seoul® LEDs, CREE® LEDs.
- *A software-optimized aspheric profile enables the generation of several different beam output patterns:narrow,medium,elliptical and wides beams.
- The high collection efficiency reaches 85% of the total flux emitted by the LEDs.
- *Lens holders are available in white or black,and provide the proper alignment the between the LEDs and the lenses,set correct distance between the lens and LED.
- *The lens holder can be glued to the PCB to provide a secure assembly.



Company: Shenzhen Hongxuan Optoelectronic Technology Co., Ltd
 Address: 33 building, Tongfuyu industrial park, Dalang Longhua new district,
 Shenzhen city, Guangdong China
 Tel: 0086-755-29059599 Fax: 0086-755-29056599 Email: opticfov@gmail.com
 Website: www.optic-fov.com

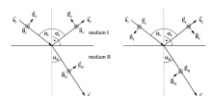

*** Holder and Lens dimensions of the 2D views**

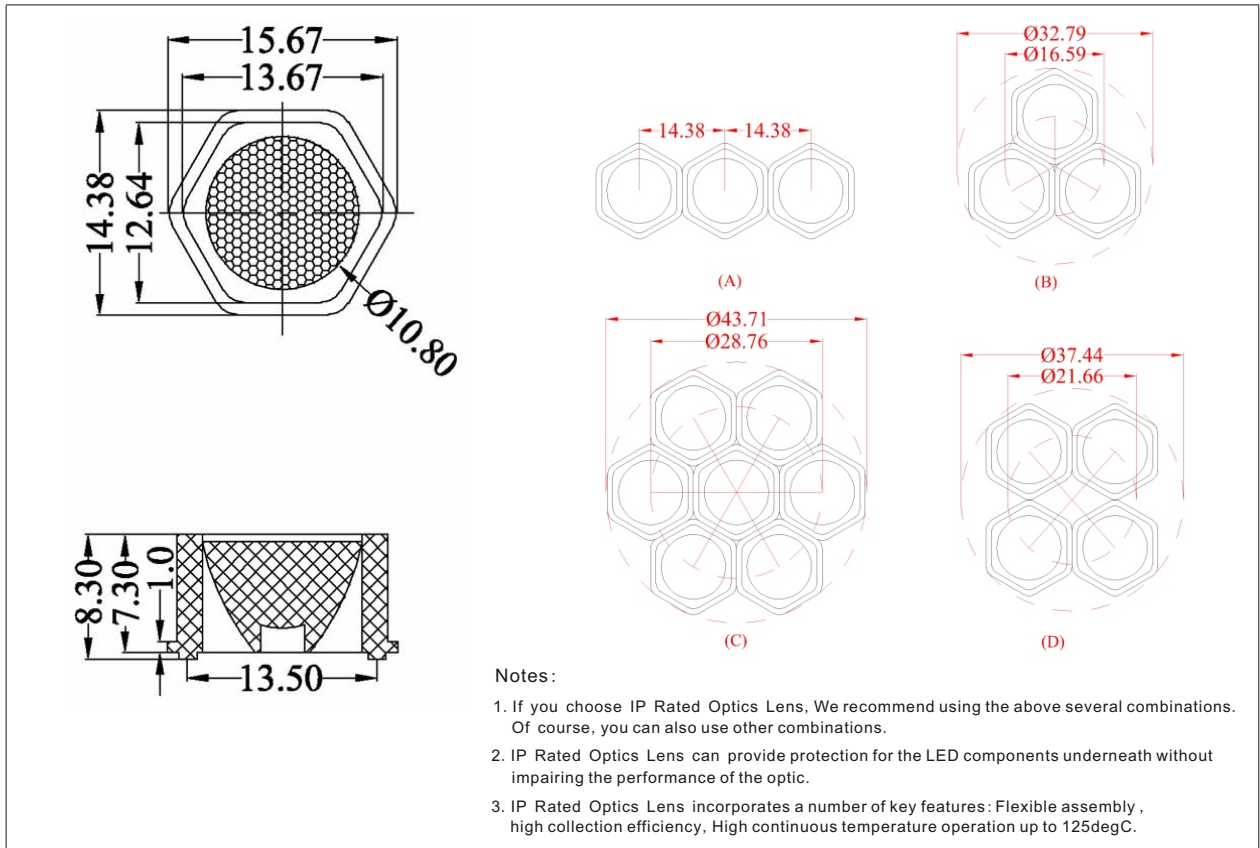

*** Beam Pattern**



*** Angular Intensity Distribution**

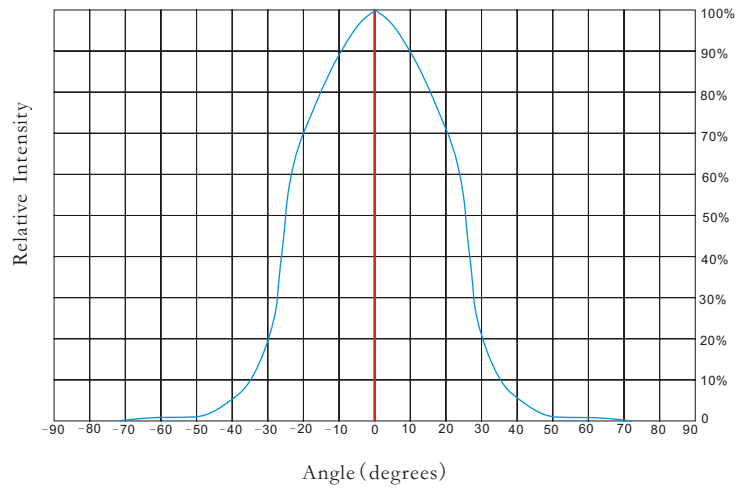

*** Typical illuminance values**

Normal Distance (m)	1.5	2	5	9
Illuminance (lux _{1W led})	N/A	N/A	N/A	N/A
Illuminance (lux _{3W led})	N/A	N/A	N/A	N/A

Notes:

*Cree flux characteristics at IF=350mA and TJ=25°C: for 1W Q5 (Part Name: XPGWHT-L1-0000-00DE4/Neutral White/107lm/Lambertian LED)

*Performance values given are typical values and will vary dependant on LED binning, colour and drive profile

*Typical illuminance values is reference data (Receiving surface of the average illuminance values).



* LED Lens materials feature table

Items	Features	Experimental methods	Units	PMMA
Physical properties	Density	ASTM D792	g/cm	1.19
	Absorbption	ASTM D570	%	2
Optical properties	Refraction index	ASTM D542		1.49
	Transmittance	ASTM D1003	%	95
	ABBE	ASTM D542		58
	Birefringence		nm	<20
Thermodynamical properties	Glass transition point	DSC	°C	150
	Heat distortion	ASTM D648 (1.85kg/cm)	°C	120
Mechanical properties	Tensile strength	ASTM D638	MPA	730
	Tensile elongation	ASTM D638	%	10
	Flexural modulus	ASTM D790	10MPA	3

* Notes:

- 1.Engineering drawings and all dimensions are in millimeters,holder and lens tolerance,respectively ± 0.10 and ± 0.05 .
- 2.Product operating temperature range $-40^{\circ}\text{C} \sim +70^{\circ}\text{C}$ (upper limit $+80^{\circ}\text{C}$).
- 3.Product storage temperature range $-40^{\circ}\text{C} \sim +70^{\circ}\text{C}$ (upper limit $+80^{\circ}\text{C}$).
- 4.Average transmittance in visible specturm $400\text{nm} \sim 700\text{nm} > 92\%$.
- 5.If necessary,clean lenses with mild soap water and soft cloth.
- 6.Never use any commercial cleaning solvents on lenses,like alcohol.
- 7.Please handle and install lenses with wearing gloves,skin oils may damage lens or its optical characteristic.

