



## \* PRODUCT DATASHEET

- \* Model:HX-15PB-1545
- \* Dimensions:
  - Lens:  $\Phi 15.00\text{mm}$  H9.12mm
  - Cone holder: N/A
  - Cylinder holder:  $\Phi 17.00\text{mm}$  H10.00mm
- \* Materials:
  - Lens: Optical Grade PMMA / PC
  - Holder: ABS
- \* Assembly Dimensions:
  - Lens with cone holder: N/A
  - Lens with cylinder holder:  $\Phi 17.00\text{mm}$  H10.00mm
- \* Surface Treatment: Stripes (Ripple Linear) Surface
- \* Beam Angle:  $15(\pm 5)*45(\pm 5)\text{deg}$
- \* For Led: CREE XQE/BD  
- \* Certification: SGS RoHs

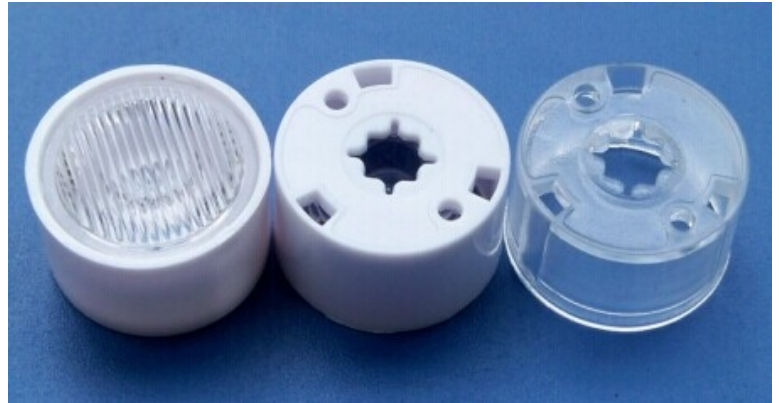

- \*Features:
  - High efficiency
  - Available in 1 beam Patterns
  - Optimized for uniform effects
  - Lens with holder
- \*Typical applications:
  - Stage lighting
  - Street lights
  - Decorative light
  - Architectural lighting
  - Down light
  - Flashlight

## \* Brief description :

\*The OPTIC-FOV (Shenzhen Hongxuan Optoelectronic Technology Co., Ltd) lens offers low-profile lenses specifically designed for the Luxeon® LEDs, Edison® LEDs, Bridgelux® LEDs, CREE® LEDs or Seoul® LEDs.

\*A software-optimized aspheric profile enables the generation of several different beam output patterns:narrow,medium,elliptical and wides beams.

The high collection efficiency reaches 85% of the total flux emitted by the LEDs.

\*Lens holders are available in white or black,and provide the proper alignment the between the LEDs and the lenses,set correct distance between the lens and LED.

\*The lens holder can be glued to the PCB to provide a secure assembly.



Company: Shenzhen Hongxuan Optoelectronic Technology Co., Ltd  
 Address: 33 building, Tongfuyu industrial park, Dalang Longhua new district,  
 Shenzhen city, Guangdong China

Tel: 0086-755-29059599 Fax: 0086-755-29056599 Email: opticfov@gmail.com

Website: www.optic-fov.com



## \* Holder and Lens dimensions of the 2D views

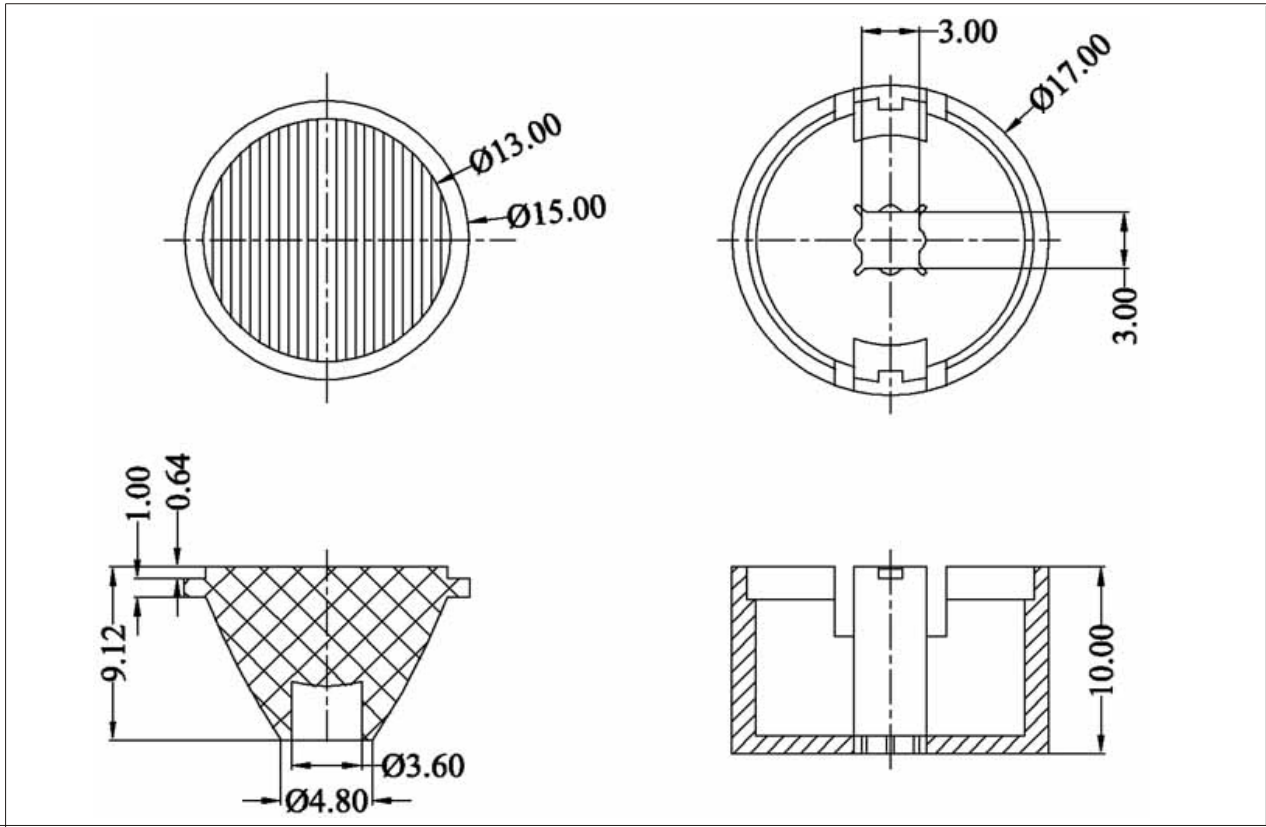

## \* Beam Pattern

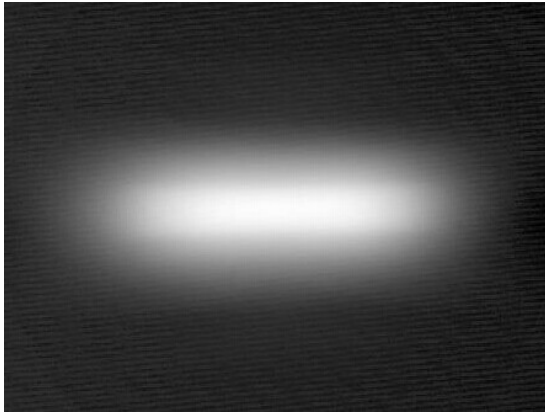

## \* Angular Intensity Distribution

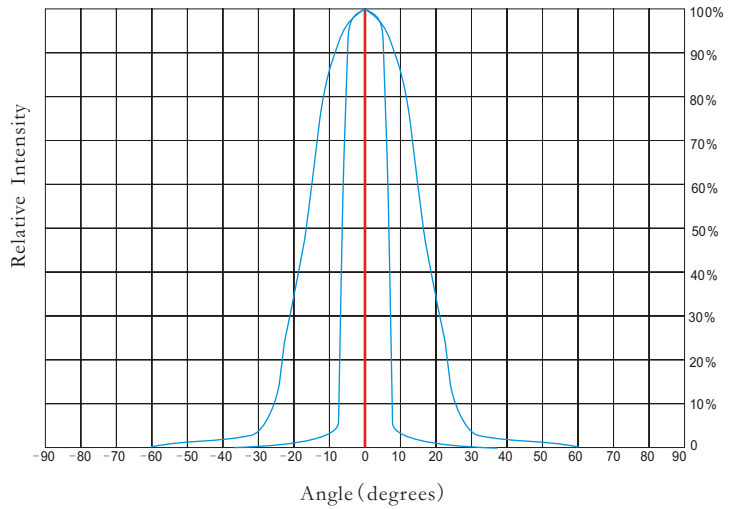

## \* Typical illuminance values

Normal Distance (m)	1.5	2	3	9
Illuminance (lux <sub>1W led</sub> )	N/A	N/A	N/A	N/A
Illuminance (lux <sub>3W led</sub> )	N/A	N/A	N/A	N/A

Notes:

\*Cree flux characteristics at IF=350mA and TJ=85°C: for 1W Q5 (Part Name: XQEAWT-00-0000-000000LDE4/Neutral White/107lm/Lambertian LED)

\*Performance values given are typical values and will vary dependant on LED binning, colour and drive profile

\*Typical illuminance values is reference data (Receiving surface of the average illuminance values).

Company: Shenzhen Hongxuan Optoelectronic Technology Co., Ltd  
 Address: 33 building, Tongfuyu industrial park, Dalang Longhua new district,  
 Shenzhen city, Guangdong China

Tel: 0086-755-29059599 Fax: 0086-755-29056599 Email: opticfov@gmail.com

Website: www.optic-fov.com

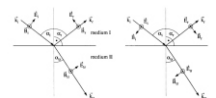

## \* LED Lens materials feature table

Items	Features	Experimental methods	Units	PMMA
Physical properties	Density	ASTM D792	g/cm	1.19
	Absorbtion	ASTM D570	%	2
Optical properties	Refraction index	ASTM D542		1.49
	Transmittance	ASTM D1003	%	95
	ABBE	ASTM D542		58
	Birefringence		nm	<20
Thermodynamical properties	Glass transition point	DSC	°C	150
	Heat distortion	ASTM D648 (1.85kg/cm)	°C	120
Mechanical properties	Tensile strength	ASTM D638	MPA	730
	Tensile elongation	ASTM D638	%	10
	Flexural modulus	ASTM D790	10MPA	3

## \* Notes:

- 1.Engineering drawings and all dimensions are in millimeters,holder and lens tolerance,respectively  $\pm 0.10$  and  $\pm 0.05$ .
- 2.Product operating temperature range  $-40^{\circ}\text{C} \sim +70^{\circ}\text{C}$  (upper limit  $+80^{\circ}\text{C}$ ).
- 3.Product storage temperature range  $-40^{\circ}\text{C} \sim +70^{\circ}\text{C}$  (upper limit  $+80^{\circ}\text{C}$ ).
- 4.Average transmittance in visible specturm  $400\text{nm} \sim 700\text{nm} > 92\%$ .
- 5.If necessary,clean lenses with mild soap water and soft cloth.
- 6.Never use any commercial cleaning solvents on lenses,like alcohol.
- 7.Please handle and install lenses with wearing gloves,skin oils may damage lens or its optical characteristic.

