





* PRODUCT DATASHEET

- * Model: HX-CRF-B
- * Dimensions:
 - Lens: 21.64x21.64mm H12.10mm
 - Cone holder: N/A
 - Square holder: 21.64x21.64mm H11.69mm
- * Materials:
 - Lens: Optical Grade PMMA / PC
 - Holder: ABS
- * Assembly Dimensions:
 - Lens with cone holder: N/A
 - Lens with square holder: 21.64x21.64mm H12.79mm
- * Surface Treatment: Stripes surface
- * Beam Angle: $10(\pm 2) \times 60(\pm 2)$ deg
- * For Led:
 - CREE X-PC/E/G/G2/TE 
 - Seoul Acriche Z5  Federal 3535 
 - Nichia 119A  LG/Samsung 3535 
 - OSRAM OSLOM SSL/Square  
- * Certification: SGS RoHs



- *Features:
 - High efficiency
 - Available in 1 beam Patterns
 - Optimized for uniform effects
 - Lens with holder
- *Typical applications:
 - Stage lighting
 - Street lights
 - Decorative light
 - Architectural lighting
 - Down light
 - Flashlight

* Brief description :

*The OPTIC-FOV (Shenzhen Hongxuan Optoelectronic Technology Co., Ltd) lens offers low-profile lenses specifically designed for the Luxeon® LEDs, Edison® LEDs, Bridgelux® LEDs OSRAM® LEDs or Seoul® LEDs.

*A software-optimized aspheric profile enables the generation of several different beam output patterns:narrow,medium,elliptical and wides beams.

The high collection efficiency reaches 85% of the total flux emitted by the LEDs.

*Lens holders are available in white or black,and provide the proper alignment the between the LEDs and the lenses,set correct distance between the lens and LED.

*The lens holder can be glued to the PCB to provide a secure assembly.



Company: Shenzhen Hongxuan Optoelectronic Technology Co., Ltd
 Address: 33 building, Tongfuyu industrial park, Dalang Longhua new district, Shenzhen city, Guangdong China
 Tel: 0086-755-29059599 Fax: 0086-755-29056599 Email: opticfov@gmail.com
 Website: www.optic-fov.com

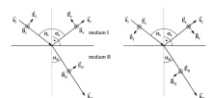

* Holder and Lens dimensions of the 2D views

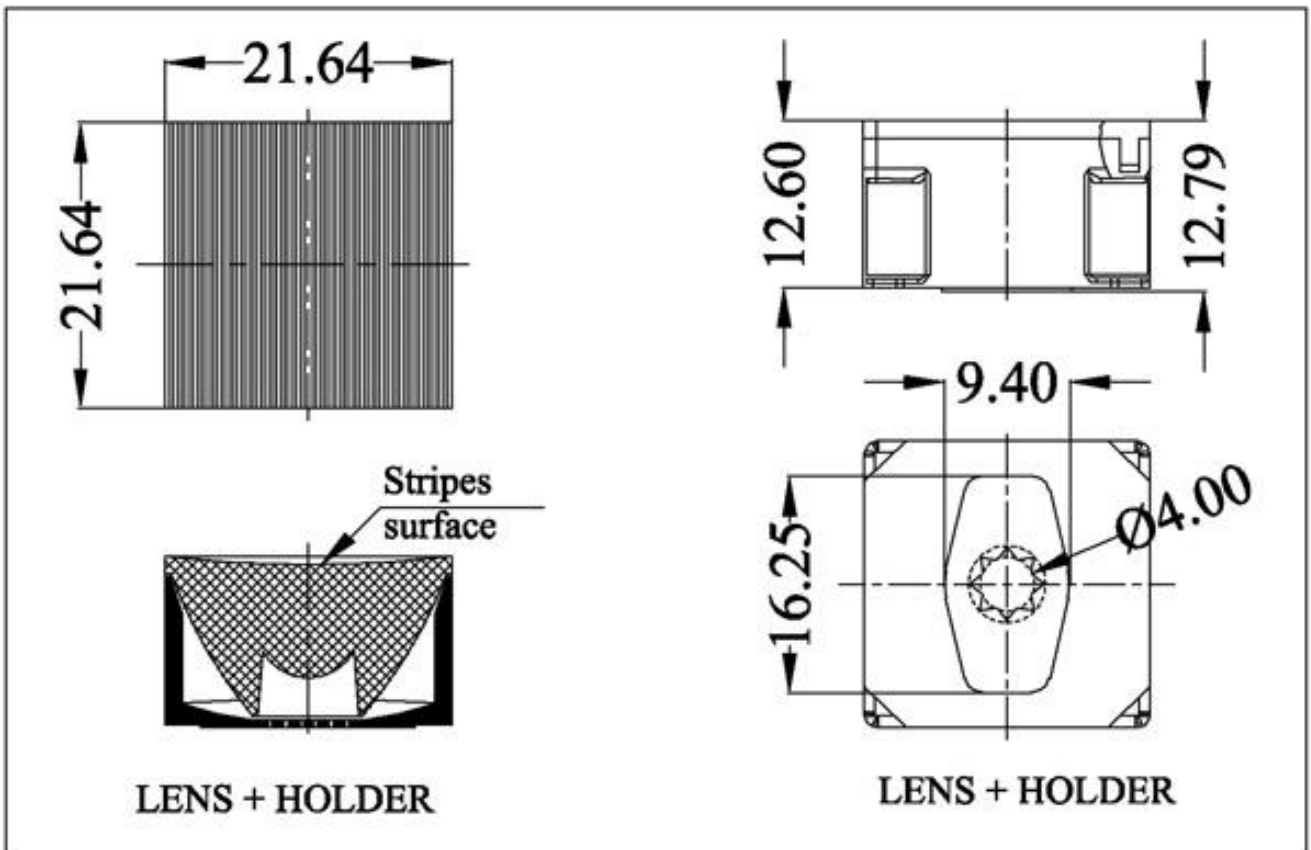

* Beam Pattern

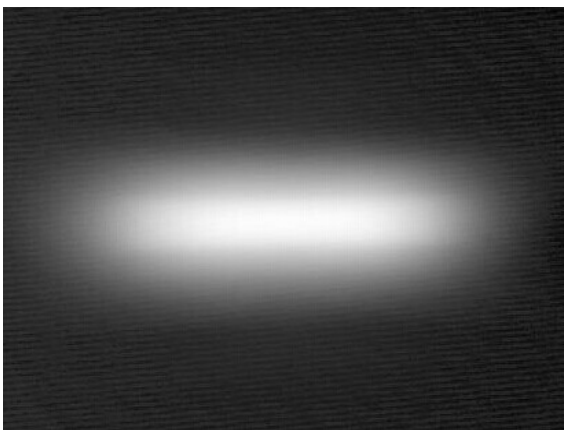

* Angular Intensity Distribution

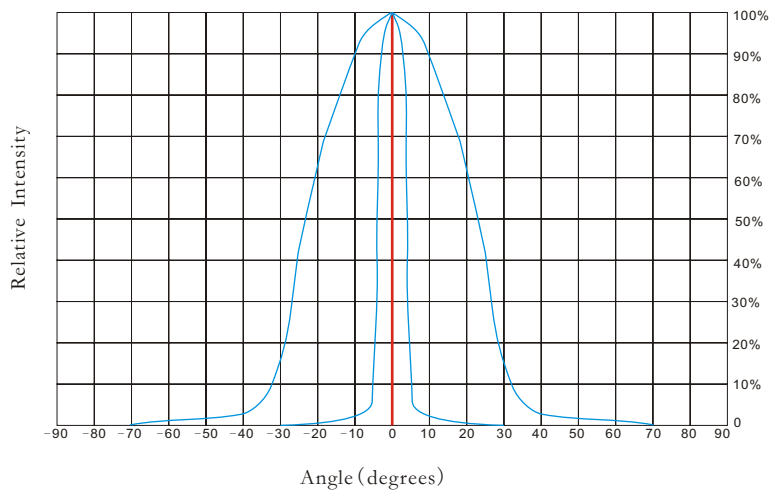

* Typical illuminance values

| Normal Distance (m) | 1.5 | 2 | 5 | 9 |
|--------------------------------------|-----|-----|-----|-----|
| Illuminance (lux _{1W led}) | N/A | N/A | N/A | N/A |
| Illuminance (lux _{3W led}) | N/A | N/A | N/A | N/A |

Notes:

*Cree flux characteristics at IF=350mA and TJ=25°C: for 1W Q5 (Part Name: XPGWHT-L1-0000-00DE4/Neutral White/107lm/Lambertian LED)

*Performance values given are typical values and will vary dependant on LED binning, colour and drive profile

*Typical illuminance values is reference data (Receiving surface of the average illuminance values).

Company: Shenzhen Hongxuan Optoelectronic Technology Co., Ltd
 Address: 33 building, Tongfuyu industrial park, Dalang Longhua new district,
 Shenzhen city, Guangdong China

Tel: 0086-755-29059599 Fax: 0086-755-29056599 Email: opticfov@gmail.com

Website: www.optic-fov.com



* LED Lens materials feature table

| Items | Features | Experimental methods | Units | PMMA |
|----------------------------|------------------------|-----------------------|-------|------|
| Physical properties | Density | ASTM D792 | g/cm | 1.19 |
| | Absorbption | ASTM D570 | % | 2 |
| Optical properties | Refraction index | ASTM D542 | | 1.49 |
| | Transmittance | ASTM D1003 | % | 95 |
| | ABBE | ASTM D542 | | 58 |
| | Birefringence | | nm | <20 |
| Thermodynamical properties | Glass transition point | DSC | °C | 150 |
| | Heat distortion | ASTM D648 (1.85kg/cm) | °C | 120 |
| Mechanical properties | Tensile strength | ASTM D638 | MPA | 730 |
| | Tensile elongation | ASTM D638 | % | 10 |
| | Flexural modulus | ASTM D790 | 10MPA | 3 |

* Notes:

- 1.Engineering drawings and all dimensions are in millimeters,holder and lens tolerance,respectively ± 0.10 and ± 0.05 .
- 2.Product operating temperature range $-40^{\circ}\text{C} \sim +70^{\circ}\text{C}$ (upper limit $+80^{\circ}\text{C}$).
- 3.Product storage temperature range $-40^{\circ}\text{C} \sim +70^{\circ}\text{C}$ (upper limit $+80^{\circ}\text{C}$).
- 4.Average transmittance in visible specturm $400\text{nm} \sim 700\text{nm} > 92\%$.
- 5.If necessary,clean lenses with mild soap water and soft cloth.
- 6.Never use any commercial cleaning solvents on lenses,like alcohol.
- 7.Please handle and install lenses with wearing gloves,skin oils may damage lens or its optical characteristic.

